

1

1

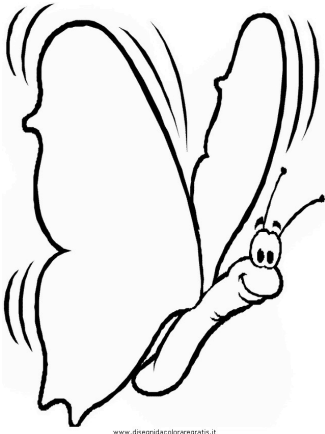

UNO

2

2

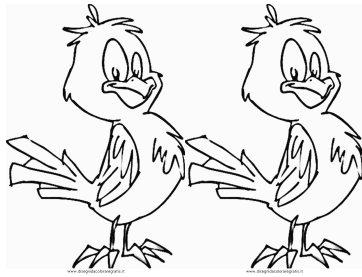

DUE

3

3

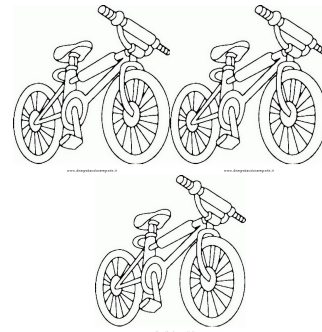

TRE

4

4

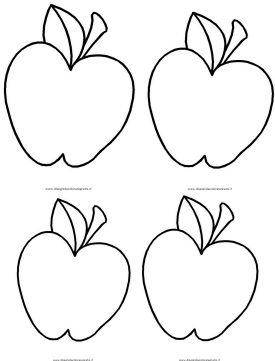

QUATTRO

5

5

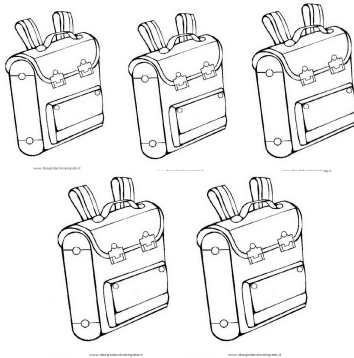

CINQUE

6

6

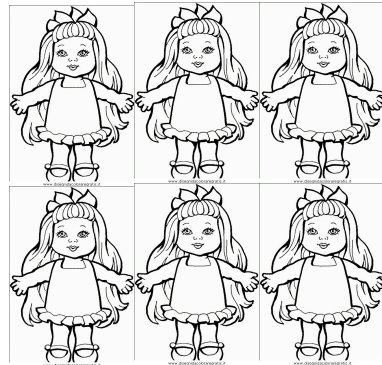

SEI

7

7



SETTE

8

8

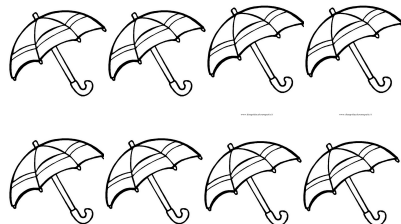

OTTO

9

9

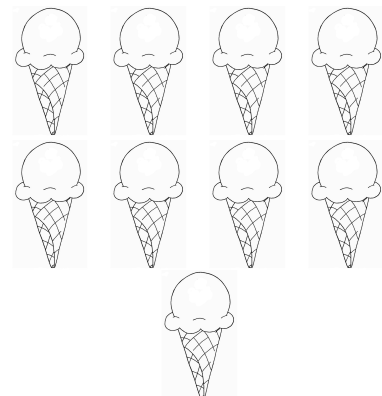

NOVE

1

1

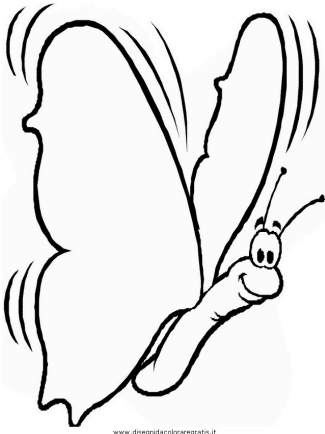

UNO

2

2

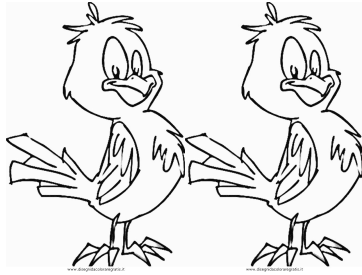

DUE

3

3

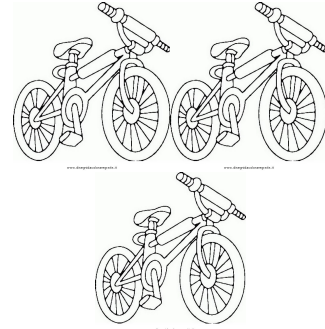

TRE

4

4

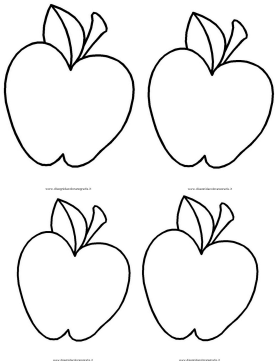

QUATTRO

5

5

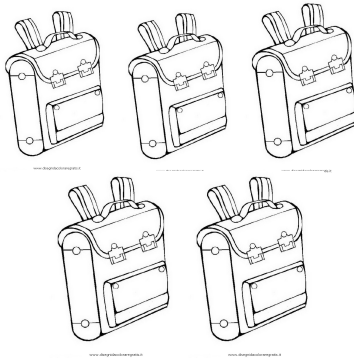

CINQUE

6

6

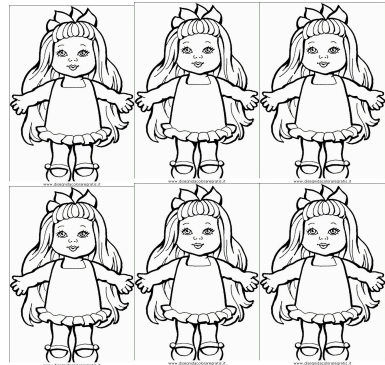

SEI

7

7



SETTE

8

8

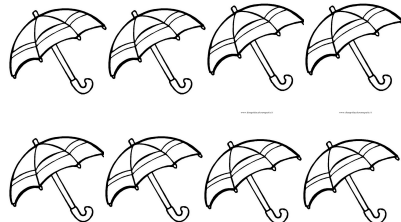

OTTO

9

9

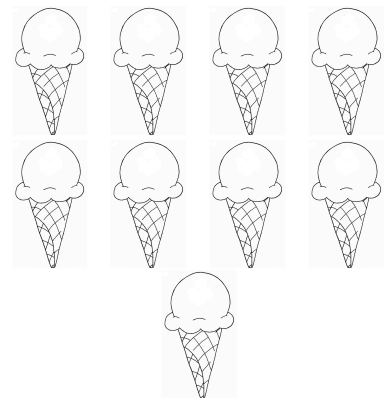

NOVE